

# Arbeitsblatt

28.07.2013

Kostenlos auf [dw-aufgaben.de](http://dw-aufgaben.de)

Aufgaben-Quickname: 6812

## Aufgabe 1

Spiegele die Figur an der Achse.

Quick:  
6812

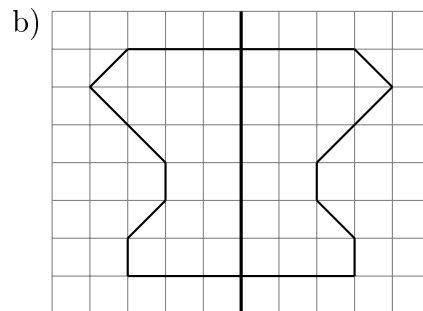
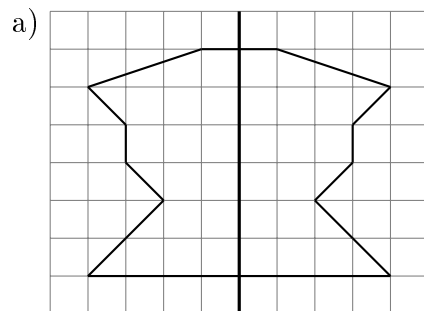

## Aufgabe 2

Spiegele die Figur an der Achse.

Quick:  
6812

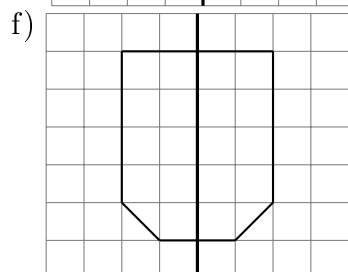
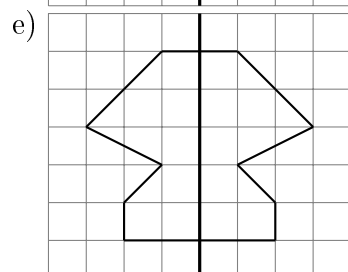
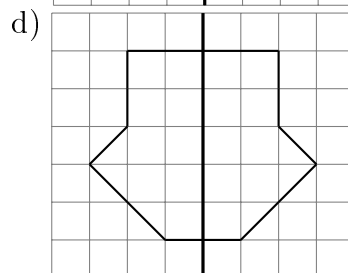
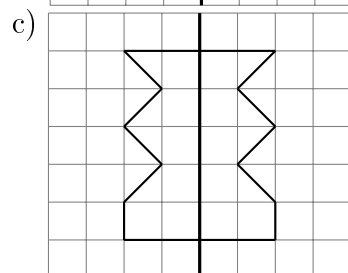
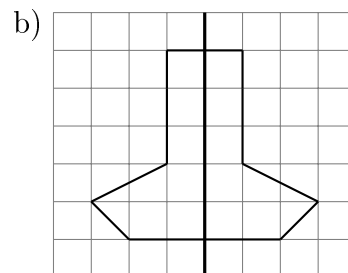
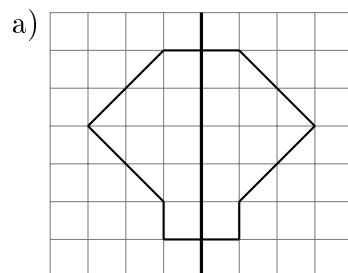

Aufgabe 3

Quick:  
6812

Spiegele die Figur an der Achse.

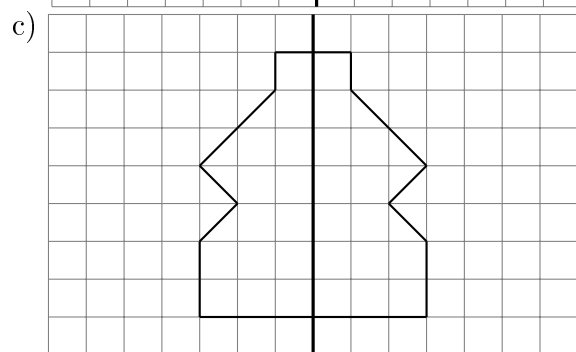
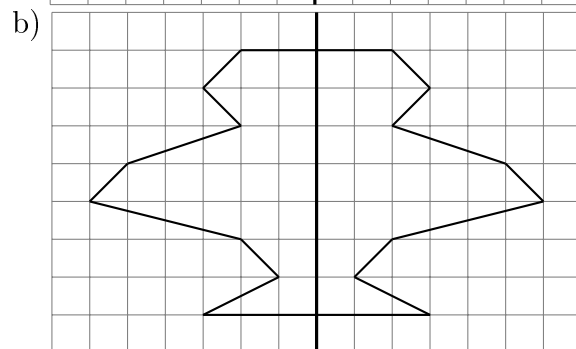
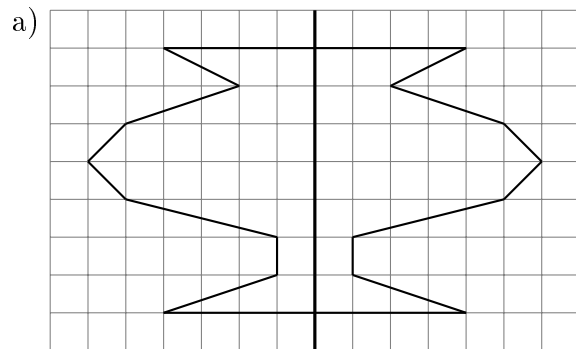

Aufgabe 4

Quick:  
6812

Spiegele die Figur an der Achse.

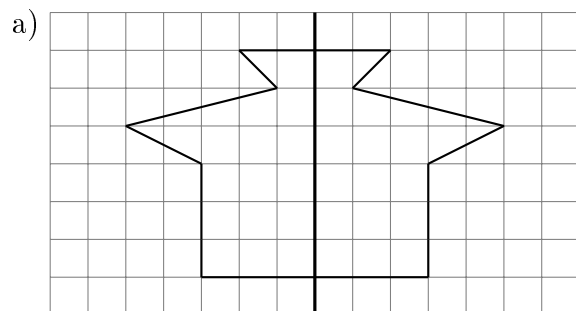

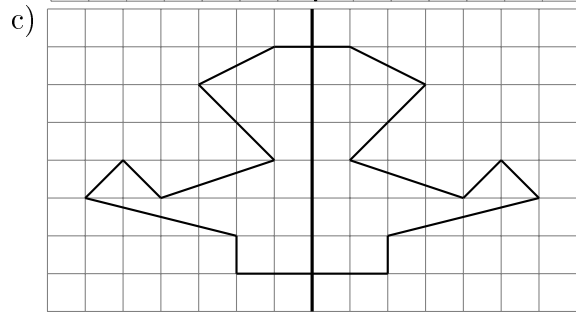
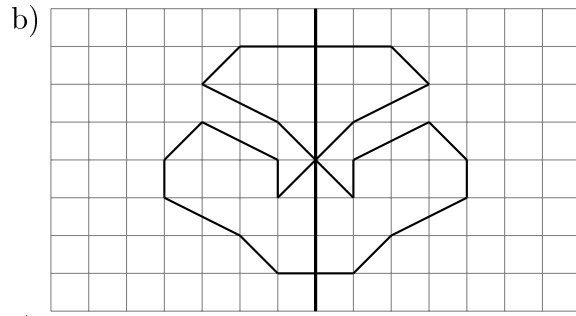

Viel Erfolg!